

S. 4,5,6,7,8,9,28,28a,29,29a 10,11,12,13,13a,14,15,16,30,31,32,33,17,17a 19,20,
 C. 5,51,6,7,8,9,10,38,50, 39,40,41,42,43,11,12,13,14, 44,45,49,31, 19,20,21, 22,46,48,4,23, 24, 49,25,26
 R. 2 26, 3, 24,4,5,25,27 6,7, 8

C16,18

plaat ant.

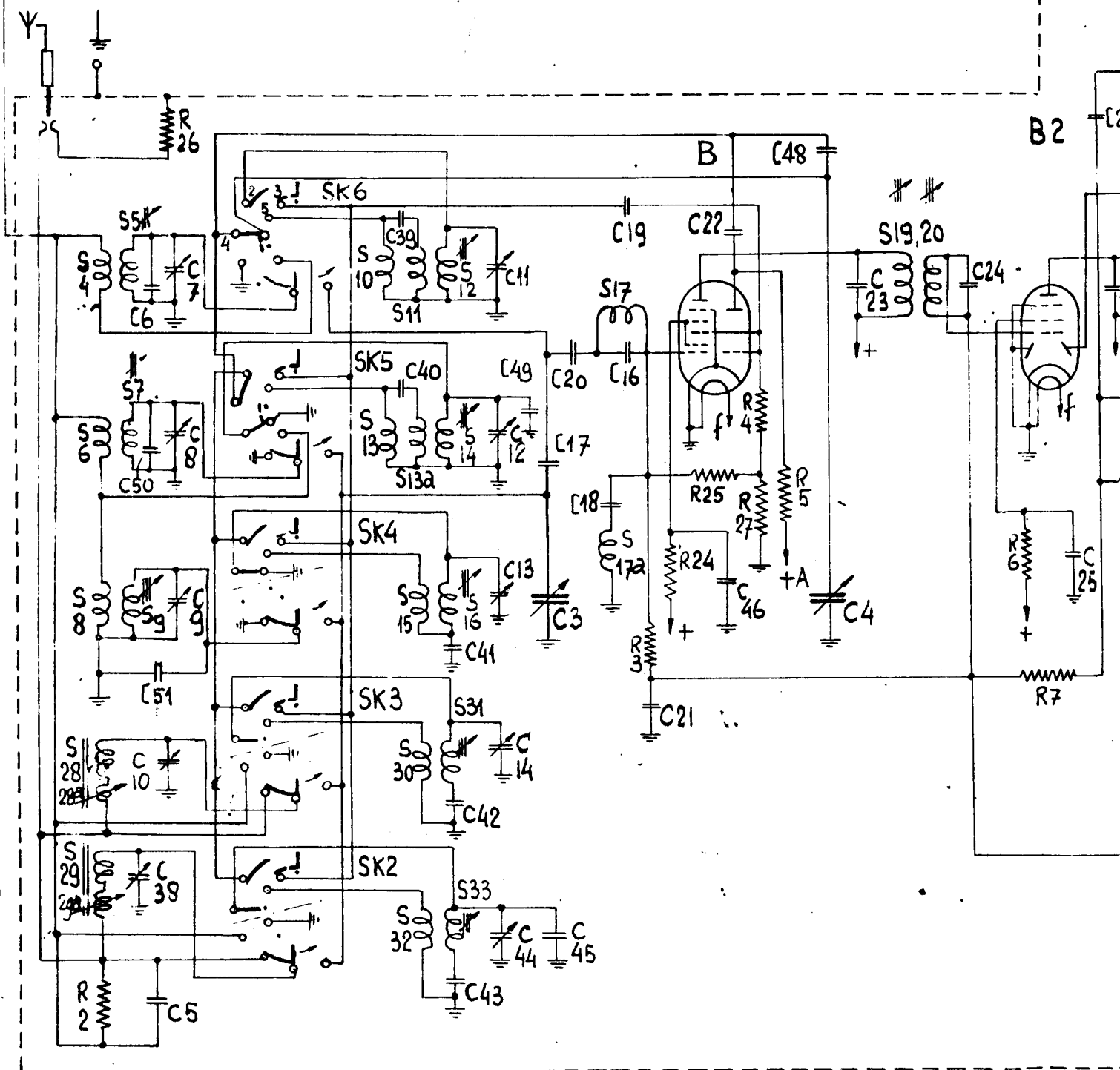

102
 x206
 106
 210
 278
 264
 340
 292
 429
 1168
 1034
 234

25
 5

6

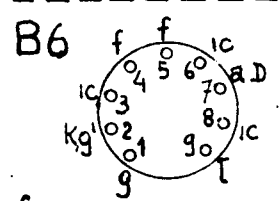
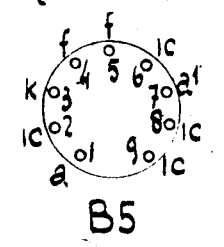
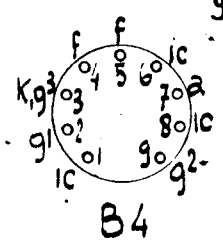
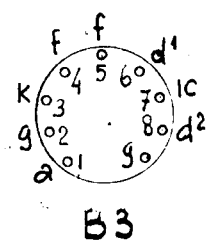
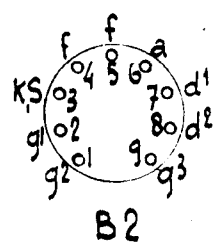
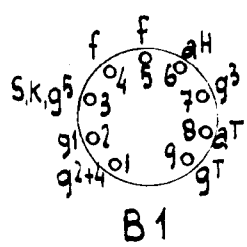

21, 22, 3, 21, 23, 24, 25, 26, 27
 49, 25, 26, 29, 30, 27, 28, 31, 32, 33, 34, 47, 2, 35, 1, 36, 52, 27
 6, 7, 8, 9, 10, 11, 12, 28, 13, 14, 15, 16, 23, 17, 18, 19, 1, 20, 21, 22, 30

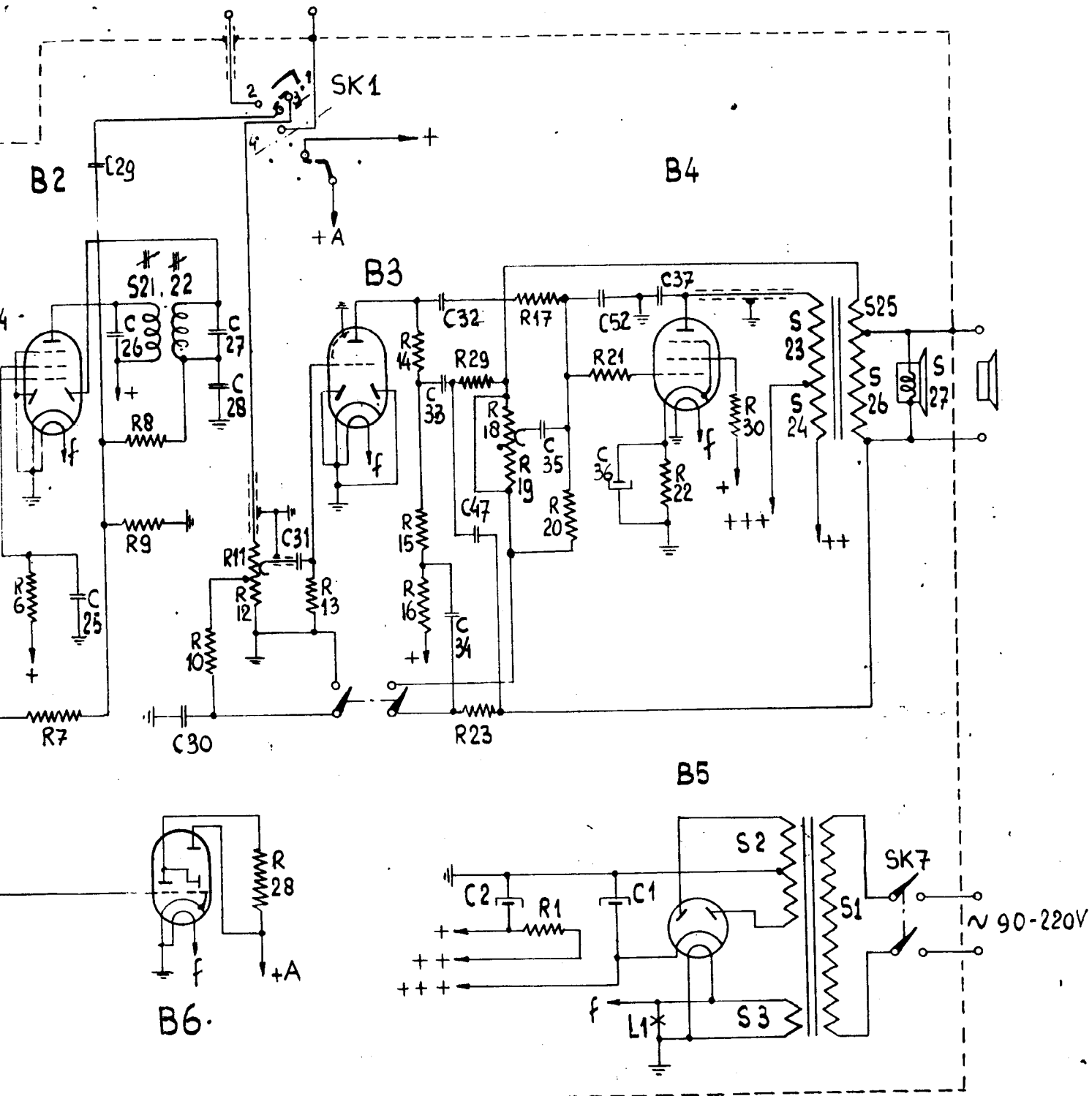

SK(toets)	1	2	3	4	5	6
functie	PU	LQ	MQ	KQ3	KQ2b	KQ2a

Opm: alle schak. getekend in stand „uit“

Ontvanger 54/55		55	BX 449 A	
Def. Principe schema		REV. SH. 21		
DESIGNER	Bouwens	DAT.	VERV.-SUIPERS	REPLACERS
N.V. PHILIPS' GLOEILAMPENFABRIEKEN			EINDHOVEN — NEDERLAND	

Eigentum der N.V. Philips' Gloeilampenfabrieken Eindhoven. Ver-
 rechtiging voor Reprintrecht als Door in welke Formaat ook
 schriftelijk toegestaan bij afname van 100 exemplaren.

Propriété de la N.V. Philips' Gloeilampenfabrieken Eindhoven. La
 reproduction ou la communication à tiers sans autorisation écrite de
 l'éditeur est formellement interdite.

Eigendom der N.V. Philips' Gloeilampenfabrieken Eindhoven.
 Reprintrecht is slechts in zoverre toeestaan, als het ten minste
 100 exemplaren afgenomen worden.

Eigentum der N.V. Philips' Gloeilampenfabrieken Eindhoven.
 Nachdruck ist nur mit schriftlicher Genehmigung der Verlegerin
 gestattet.

AANVULLING HOOFDSTUKLIJST							
1	Buis		EC81				B1
1	Buis		BF80				B2
1	Buis		BC81				B3
1	Buis		EL84				B4
1	Buis		EZ80				B5
1	Buis		EM80				B6
1	Verlichtingslamp		8024N-91				L1
1	Luidspreker	*	A D 3700 M				S27
AANVULLING CHASSISSTUKLIJST							
							S1
1	Nettransf.		A3 142 44	2x1500	W		S2
				39	W		S3
1	Ant.spoel	KG2a	A3 118 40	21 2/4	W		S4
				7 2/4	W		S5
1	Ant. spoel	KG 2b	A 3 118 41	21 2/4	W		S6
				13 2/4	W		S7
1	Ant. spoel	KG 3	A3 125 33	142 2/4	W		S8
				69 2/4	W		S9
1	Osc. spoel	KG2a	A3 127 28	55	W		S10
				9 1/4	W		S11
				10 2/4	W		S12
1	Osc. spoel	KG 2b	A3 125 58	35	W		S13
				8 1/4	W		S13a
				18 2/4	W		S14
1	Osc. spoel	KG 3	A3 125 68	17 2/4	W		S15
				61 2/4	W		S16
1	Zwig-sperkrs.spoel		A3 118 80	940	W		S17
				304	W		S17a
1	M.F. spoel		A3 126 84	299	W		S19
				223	W		S20
				110	pF		C23
				195	pF		C24
1	M.F. spoel		A3 126 84	299	W		S21
				223	W		S22
				110	pF		C26
				195	pF		C27
1	Luidspreker transf.		A3 169 71	3500	W		S23
				35	W		S24
				250	W		S25
				120	W		S26

QUANTUM TOT.	QUANT. P. EENH.	OMSCHRIJVING DES-UMS.	MATERIAAL MAT.	AFMETING DIM.-ABM.	NORM STAND.-NORME	CODE/TEK./TYPE NR. DRAW.-DESSIN-ZEICH.	FORM.	OPMERKING REM.-BEM.	POST
--------------	-----------------	-----------------------	----------------	--------------------	-------------------	--	-------	---------------------	------

* Indien niet in voorraad, hiervoor gebruiken 49 241 00 (zie tevens opm. *** op mech. stuklijst)

Ontvanger 54/55 BX449A

MECH./ELECTR. STUKLIJST — PARTLIST — NOMENCL. — STUCLIST		Bouwens		DAT. 11-2-57		VERV.-SUPERS. RENPL.-ERS.		BL. 11	
A		N.V. PHILIPS' GLOEILAMPENFABRIEKEN		EINDHOVEN — NEDERLAND		FORM. A			

